

Varenummer: 20055509
 Beskrivelse: E+G Kobling for radial forskydning
 GN 240-M6-B

Mål

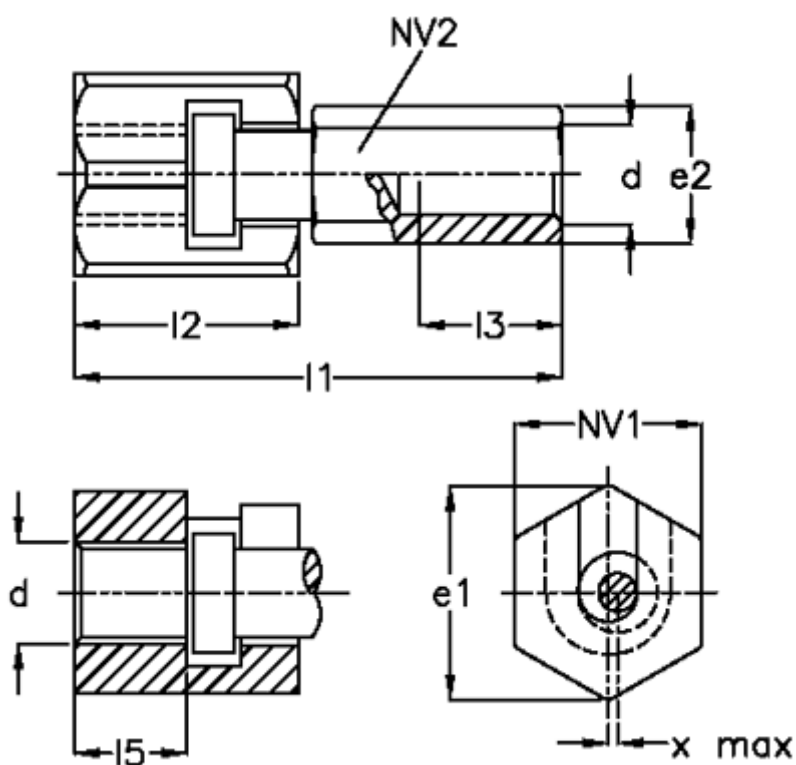

d	= M 6x1	Max træk-skub kraft N = 2500
e1	= 21.0	NV 1 = 19
e2	= 11.0	NV 2 = 10
l1	= 37.5	
l2	= 18.0	
l3	= 11.0	
l5 +1	= 9.0	
Max forskydning = 0.6		